





















Queens Theatre, Barnstaple  
 Show:  
 Version: 4 - 02/02/2023  
 Designer:

**Key**

-  Q Wash 560z
-  Rouge R2 Wash
-  Era 300
-  Rush MH2
-  Mac 350 Entour
-  Intimidator Spot 250
-  Intimidator Beam 350
-  Colorado Btn 144
-  Hex Par
-  Geyser
-  Ice Fog
-  Cantata 18/32
-  S4 Fresnel
-  S4 Parcan
-  UV Cannon?
-  S4 Zoom 15/30
-  Follow Spot
-  S4 Zoom 26
-  Par 64

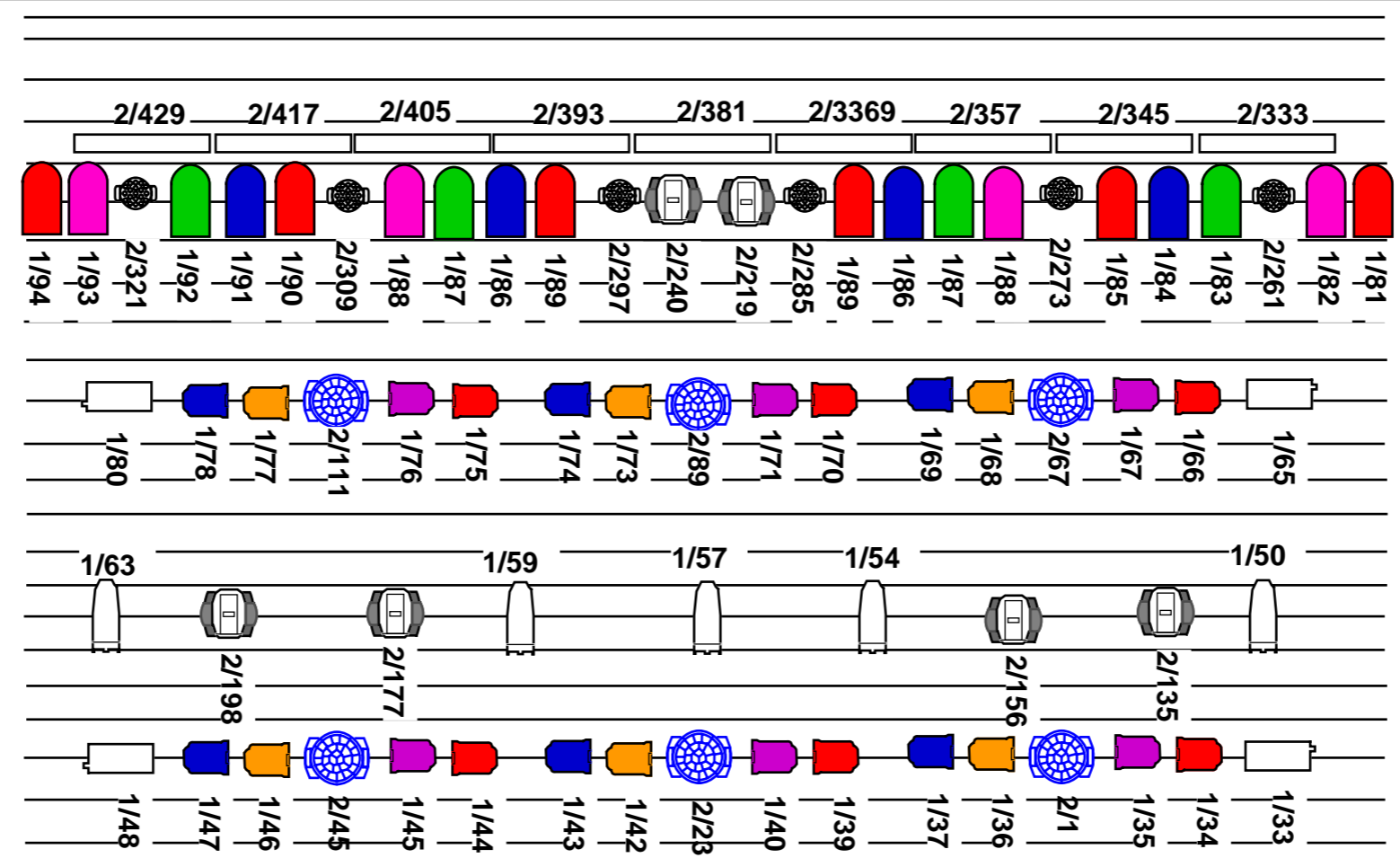

Bar 23  
 Bar 22  
 Bar 21  
 Bar 20  
 Bar 19  
 Bar 18  
 Bar 17  
 Bar 16  
 Bar 15  
 Bar 14  
 Bar 13  
 Bar 12  
 Bar 11  
 Bar 10  
 Bar 9  
 Bar 8  
 Bar 7  
 Bar 6  
 Bar 5  
 Bar 4  
 Bar 3  
 Bar 2  
 Bar 1

-  1/441
- 1/455
- 1/469
- 1/483
-  2/441
- 2/447
- 2/453
- 2/459
- 2/465
- 2/471
- 2/477
- 2/483
- Star Cloth
- 1/509
- 1/510
- 1/511
- 1/512

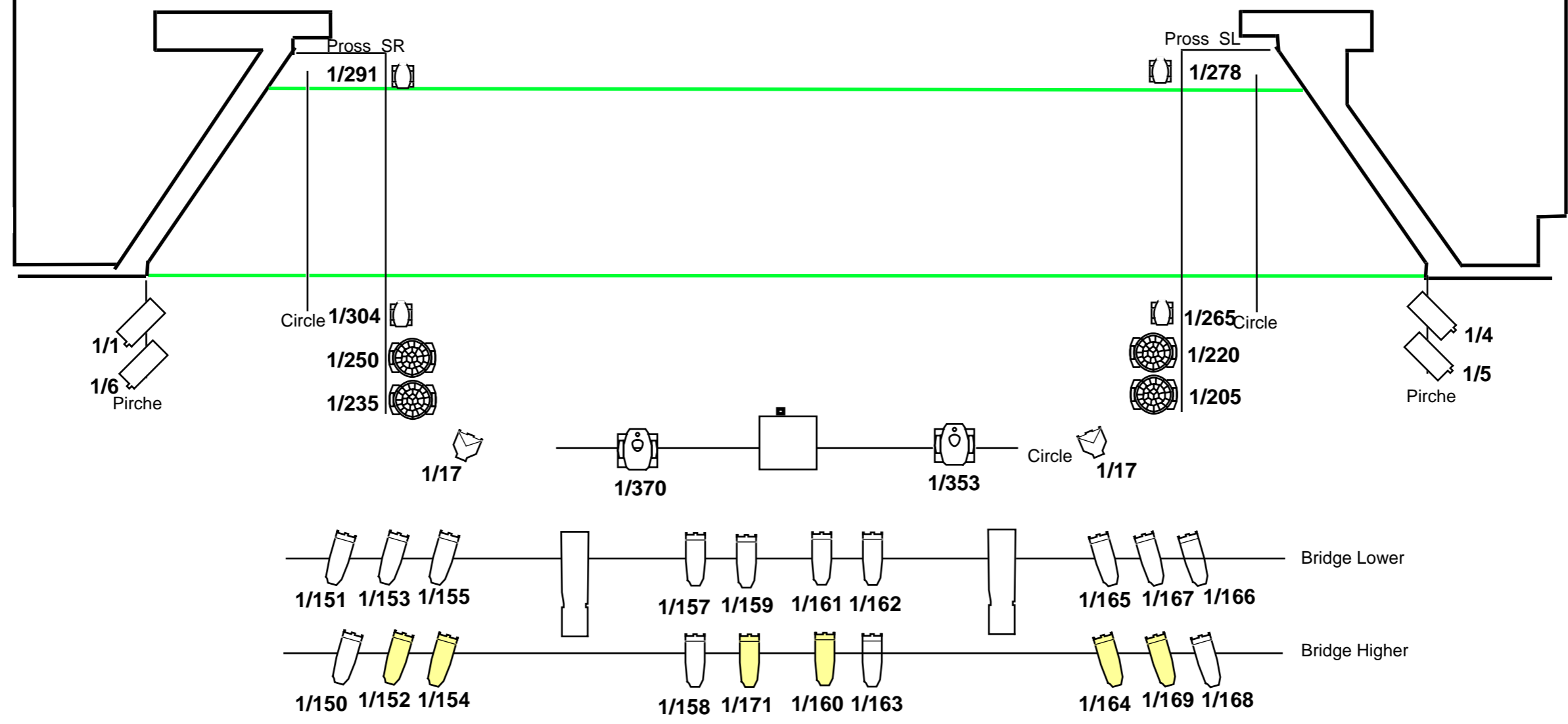

Bridge Lower  
 Bridge Higher

**USR BOX**  
15a - Circuits 121 - 144  
Soca - Circuits 97 - 120  
DMX 3 (univers 2)  
Coms  
15a Test Circuit  
Cue Light

**SR**  
32a Single Phase x3  
63a Single Phase x3  
125 or 63a 3 Phase

**USL BOX**  
15a - Circuits 97 - 120  
Soca - Circuits 97 - 120  
DMX 2 (Univers 2)  
Coms  
15a Test Circuit  
Cue Light

**Dimmer Room**  
DMX4 + 5 (Universe 2)  
Universe 1 In / Out

**SL Fly Floor**  
15a - circuits 33 - 96  
DMX1 (Univers 2)  
Universe 3 Splitter

**DSR**  
Coms  
Cue Light  
13a x2  
Sound x6 13a socket  
Sound x1 32a single phs  
Sound x1 63a single phs

**DSL BOX**  
Xlr Tie Lines from box19-24  
Xlr Tie Lines to box 1-16  
Coms  
Universe 3 Output  
Cue Light

**SR Apron**  
15a Circuits - 21,23,24,27,39,31

**SL Apron**  
15a Circuits - 22,24,26,28,30,32

**DSM DESK**  
13a x4  
Sound x4 13a  
15a Independant x2  
Stage Audio Tie In Point

**Pirch SR**  
15a - Circuits 1, 6 - 9

**Circle SR**  
15a - circuits 17, 18, 19, 20  
16a Socket  
DMX (Universe1)

**Circle SL**  
15a - circuits 11, 10, 19, 20  
16a Socket  
DMX (Universe1)

**Pirch SL**  
15a - Circuits 1-5

**Circle Front**  
15a Circuits - 13, 15, 15, 16, 17, 18

**Bridge**  
15a - Circuits 150 - 173  
Coms  
15a Independant x2  
13a x 2

